



# ALACO Ladder Company

888-310-7040 www.alacoladder.com  
Fax - 909-591-7565  
Email - sales@alacoladder.com

## Loft Ladder Estimate Form

### How to order or get an estimate on your ladder

Complete all the information on this form and email or fax back all 3 pages.

We will contact you with an estimate or to arrange delivery of your Loft Ladder and Track.

## 1. Make Ladder Choices

Check all boxes that apply.

### Specify Ladder

**Rolling Ladder (S-100)**

Ladder includes upper roller assembly or hook assembly, track and lower wheel assembly. Also pivots against wall when not in use.

**Pivotal Ladder (S-200)**

No lower wheels. Ladder pivots from wall with pivotal bracket assembly.

**Fixed Ladder (S-300)**

Fixed ladder that neither pivots nor rolls.

### Specify Material

**Material:**

- Wood       Aluminum

**Wood Type:**

- Birch       Cherry       Mahogany  
 Maple       Red Oak       White Oak  
 Walnut       Alder       Specify Other: \_\_\_\_\_

**Wood Finish:**

- Unfinished       Clear       Stain to Match  
 Specify Minwax Stain: \_\_\_\_\_

**Wood Finish also select:**  Gloss  Satin

**Aluminum Ladder:**

Aluminum loft ladders come standard with no finish. Ladders can be powdercoated in the following standard colors. Optional colors are also available.

- Matte Black       Gloss Black       Bronze  
 Matte White       Gloss White       Specify Other: \_\_\_\_\_

Contact \_\_\_\_\_

Company \_\_\_\_\_

Address \_\_\_\_\_

City \_\_\_\_\_ State \_\_\_\_\_ Zip \_\_\_\_\_

Phone \_\_\_\_\_ Fax \_\_\_\_\_

Email \_\_\_\_\_

### Specify Handrails

Handrails do not come standard.

**Flush Handrails:**

- Left Side  
 Right Side  
 Both Sides

**Extended Handrails:**

- Left Side  
 Right Side  
 Both Sides

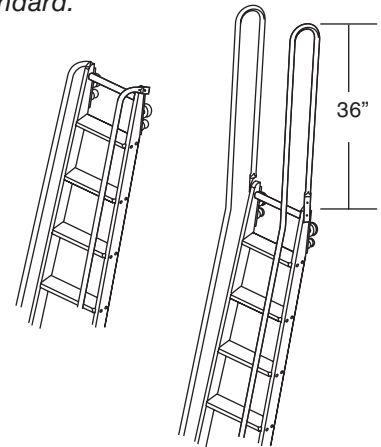

### Specify Wheel Housing

S-100 Rolling Only.

**Sunburst Pattern**  
(Wood Ladder only)

- Contemporary**  
 Aluminum Ladder  
 Wood Ladder

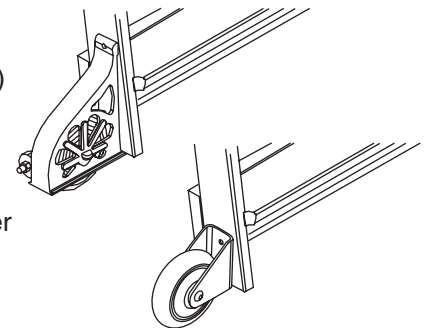



# ALACO Ladder Company

888-310-7040 www.alacoladder.com  
Fax - 909-591-7565  
Email - sales@alacoladder.com

## Loft Ladder Estimate Form

### Specify Hardware Finish

All hardware, including wheel housing, upper roller assembly, handrails, metal track (if ordered), brackets, braces and bolts will be done in this finish.

- Chrome:  Satin
- Nickel:  Satin  Antique
- Copper:  Satin  Antique
- Brass:  Satin  Antique  
 Heavy/No Lacquer
- Bronze:  Antique/Oil Rub
- Powdercoated Finishes:
- Matte Black  Gloss Black  
 Matte White  Gloss White  
 Bronze

### Specify Upper Assembly

S•100 Rolling Only.

- Roller Assembly**  
For affixed rolling ladder.

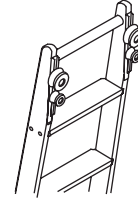

- Hook Assembly**  
For a removable ladder.

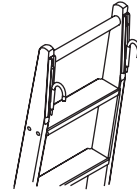

- Optional Safety Tread**  
No-slip tread added to all steps  
(wood only)

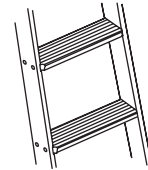

## 2. Make Track & Bracket Choices

Check the box that applies.  
See Step 3 for specifying Curved Tracks.

### For Steel Tracks

S•100 Rolling Only.

Track and brackets to match specified hardware finish.  
Brackets must be mounted no more than every 48"

- Vertical Brackets for Ladders  
with Roller Assembly**

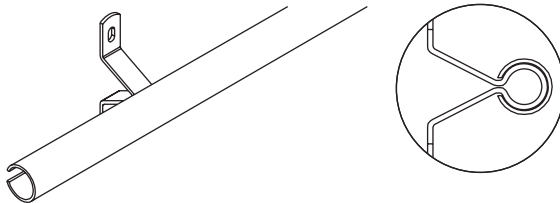

- Vertical Brackets for Ladders  
with J Hook Assembly**

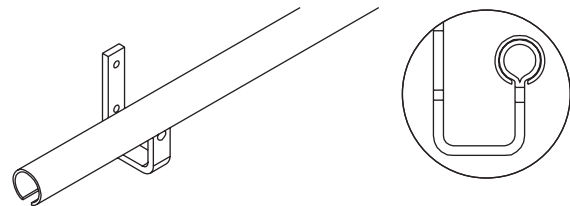



# ALACO Ladder Company

888-310-7040 www.alacoladder.com  
Fax - 909-591-7565  
Email - sales@alacoladder.com

## Loft Ladder Estimate Form

### 3. Provide Dimensions

Fill in all dimensions that apply.

#### Loft Ladder Dimensions

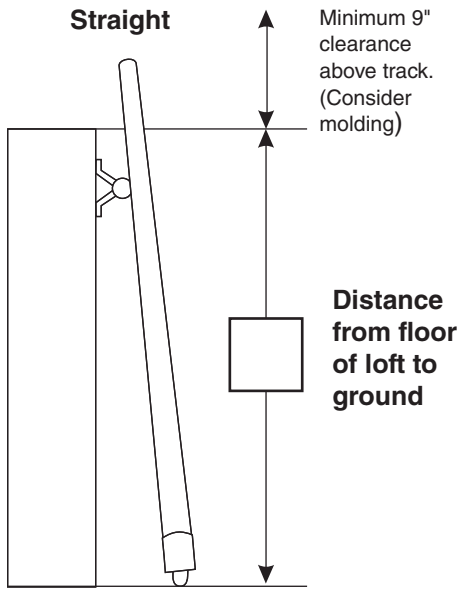

Number of brackets supplied will be based on 30" spacing.

- Check here if mounting surfaces require more brackets.
- If you would like ALACO to assist you in figuring your dimensions, please check this box and fax us a separate sketch of your room or floor plans.

#### Track Dimensions

